

**FAVEKER<sup>®</sup>** GA20

ARCHITECTURAL CERAMICS

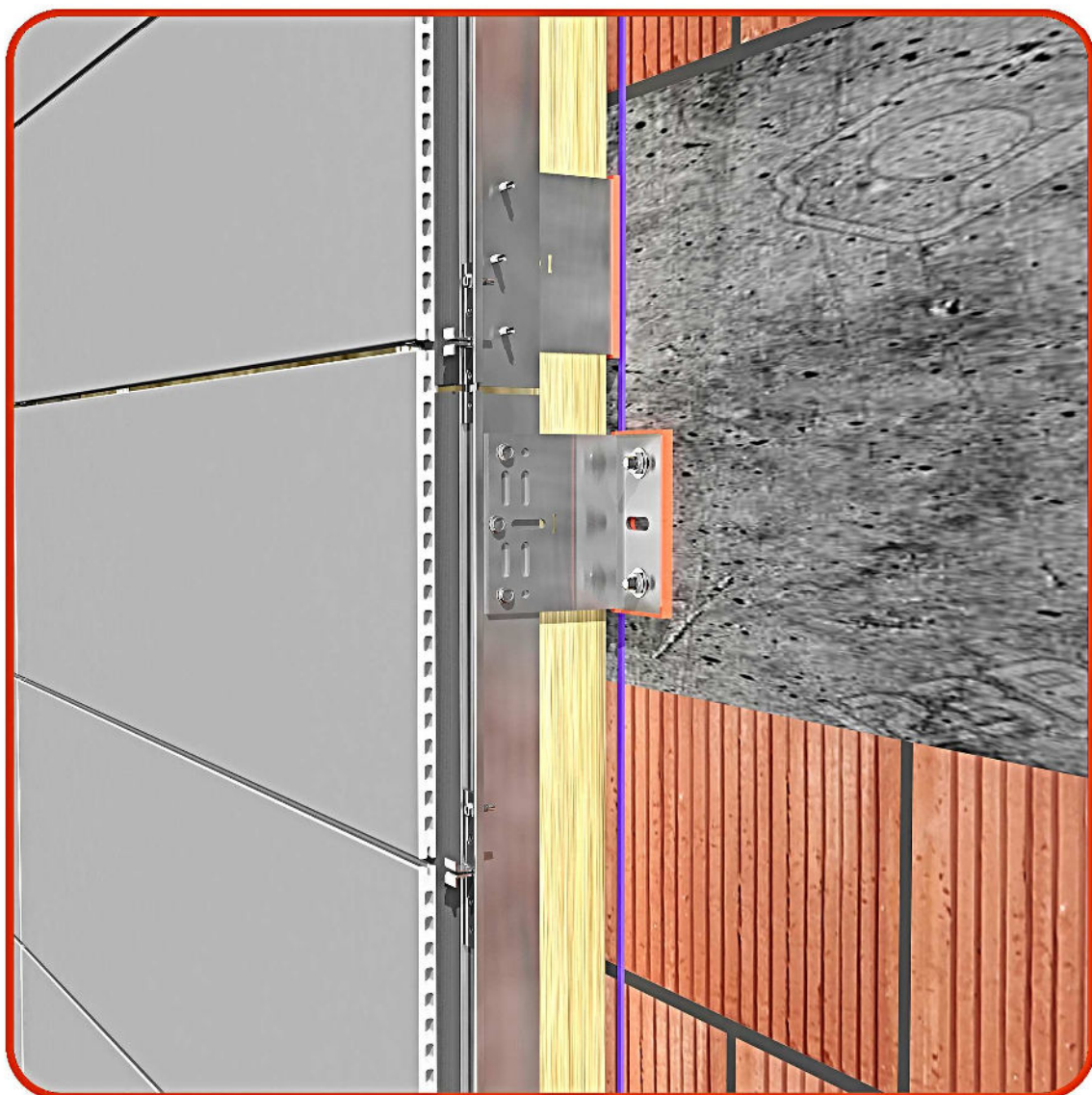

MANUAL DE COLOCACION GA-20  
*INSTALLATION GUIDE GA-20*

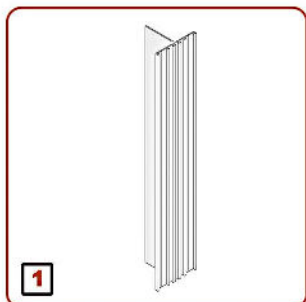

**1**  
PERFIL T STANDAR 6ML  
*T STANDARD PROFILE 6ML*

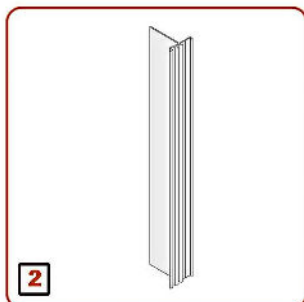

**2**  
PERFIL T LATERAL 6ML  
*L LATERAL PROFILE 6ML*

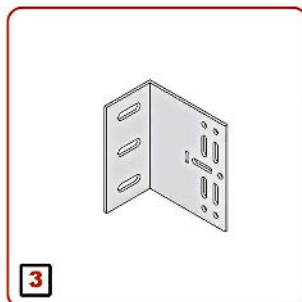

**3**  
MENSULAS DE SUSTENTACION 120  
*VERTICAL LOAD BRACKET 120*

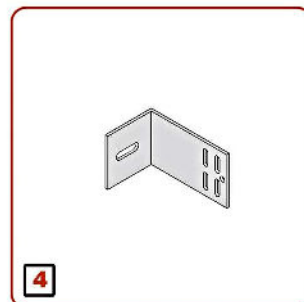

**4**  
MENSULA DE RETENCION 60  
*HORIZONTAL LOAD BRACKET 60*



**5**  
EPDM PERFIL T ESTANDAR  
*EPDM T STANDARD PROFILE*



**6**  
EPDM PERFIL T LATERAL  
*EPDM L LATERAL PROFILE*

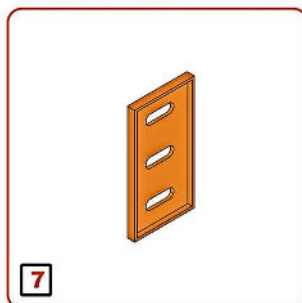

**7**  
TERMOSTOP MENSULA 120  
*TERMOSTOP 120MM*

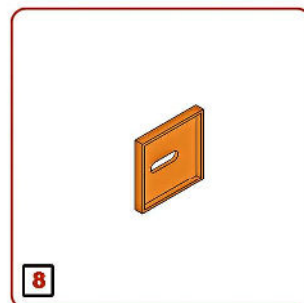

**8**  
TERMOSTOP MENSULA 60  
*TERMOSTOP 60MM*

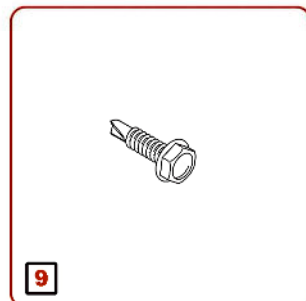

**9**  
TORNILLO AUTOTALADRANTE 5,5  
*SELF-DRILLING SCREW 5,5*

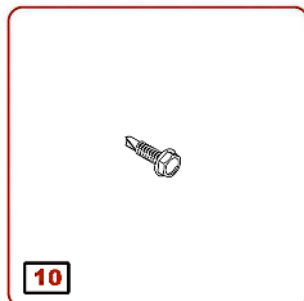

**10**  
TORNILLO AUTOTALADRANTE 4,8  
*SELF-DRILLING SCREW 4.8*

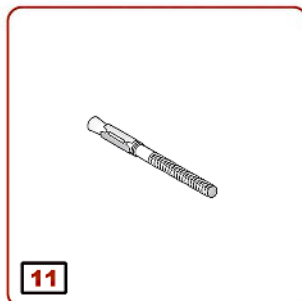

**11**  
TACO METALICO EXPANSIVO  
*EXPANSIVE METALLIC FIXER*



**12**  
FIJACION POLIAMIDA TNUX  
*POLIAMIDE TNUX FIXER*

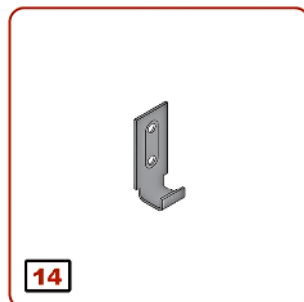
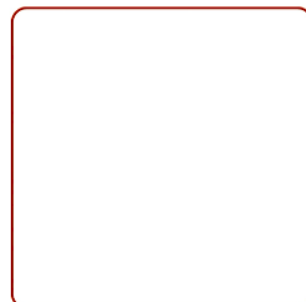

**14**  
CLIP SIMPLE SISTEMA GA-16  
*CLIP GA16 SIMPLE*

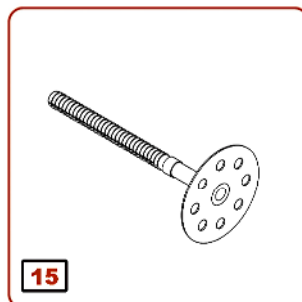

**15**  
ROSETA AISLANTE  
*INSULATION FIXER*

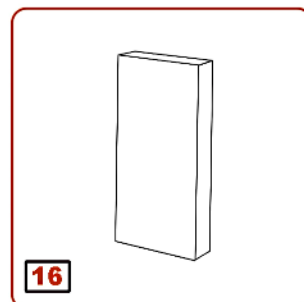

**16**  
AISLANTE  
*INSULATION*

**PASO 1 / STEP 1**

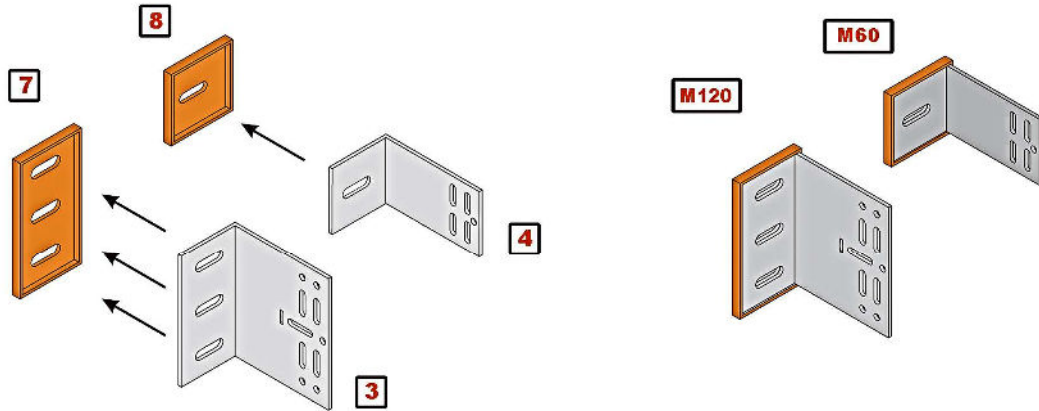

**PASO 2 / STEP 2**

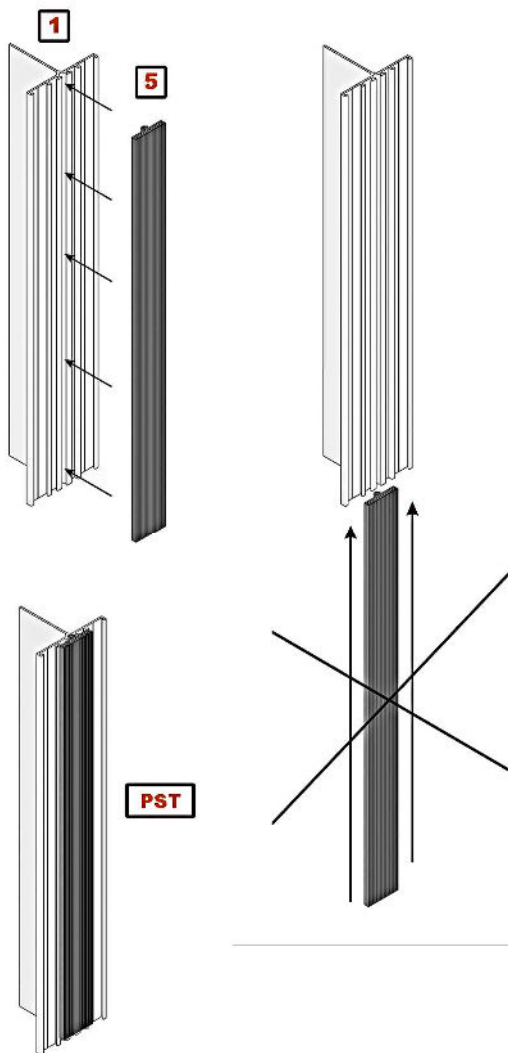

**PASO 3 / STEP 3**

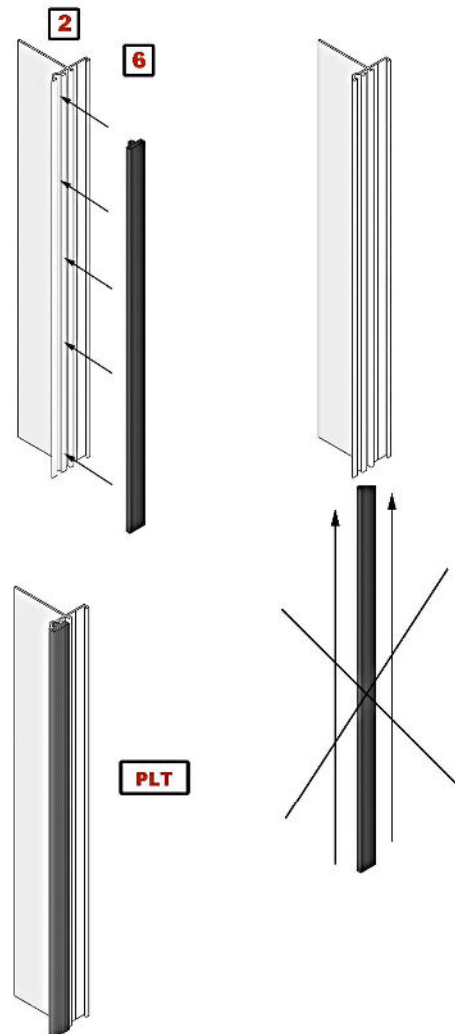

**PASO 4 / STEP 4**

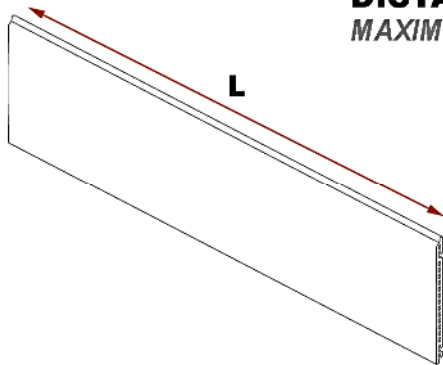
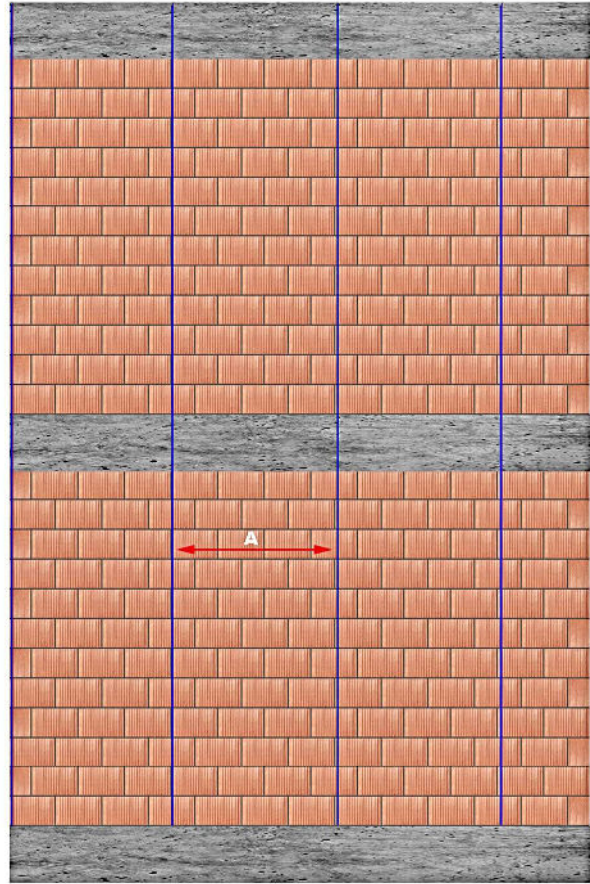
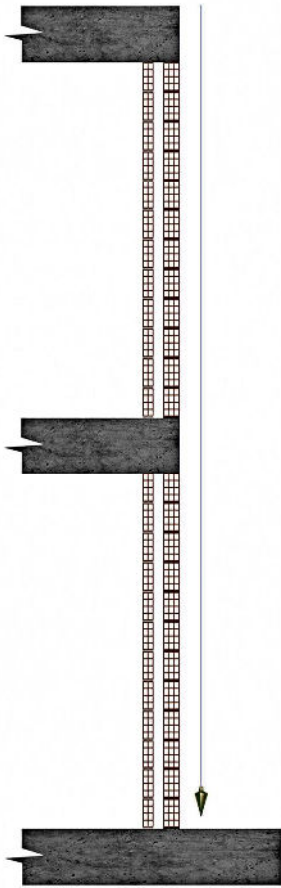

**DISTANCIA HORIZONTAL ENTRE MENSULAS**  
MAXIMUM HORIZONTAL DISTANCE BETWEEN BRACKETS

<b>A</b>	<b>L</b>
<b>1000</b>	<b>992</b>
<b>800</b>	<b>792</b>

**PASO 4 / STEP 4**

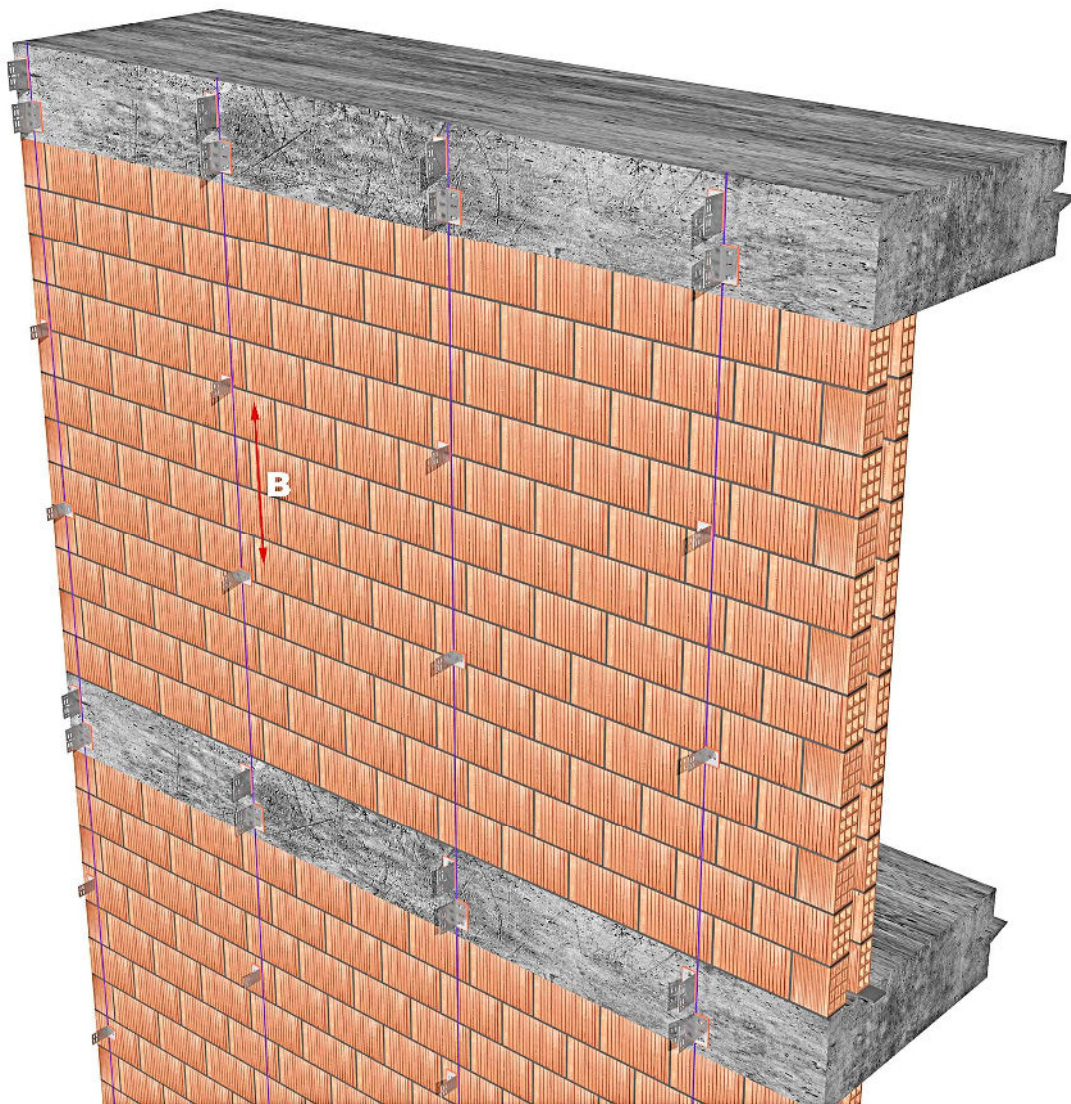

**B = L (LONGITUD DE PLACA) + P ( TIPO DE PERFIL)**  
*B = L ( CERAMIC TILE LENGTH) + P ( PROFILE TYPE)*

DISTANCIA VERTICAL MAXIMA ENTRE MENSULAS MAXIMUM VERTICAL DISTANCE BETWEEN BRACKETS			
LONGITUD LENGTH	PLACA 800 CERAMIC TILE 800	PLACA 1000 CERAMIC TILE 1000	
PERFIL EN T T PROFILE	<b>1625 MM</b>	<b>1490 MM</b>	
PERFIL EN L L PROFILE	<b>600 MM</b>	<b>500 MM</b>	

**PASO 5 / STEP 5**

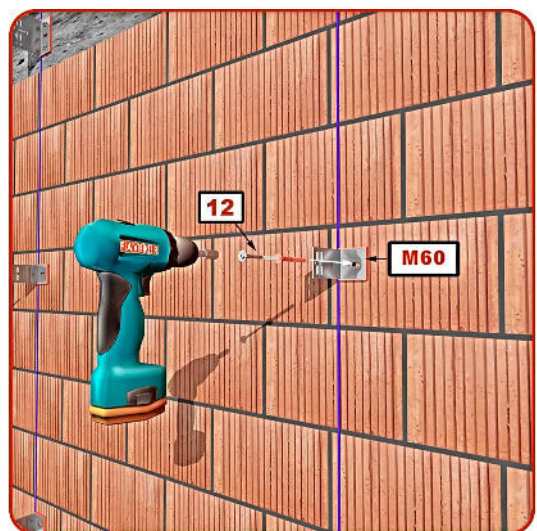
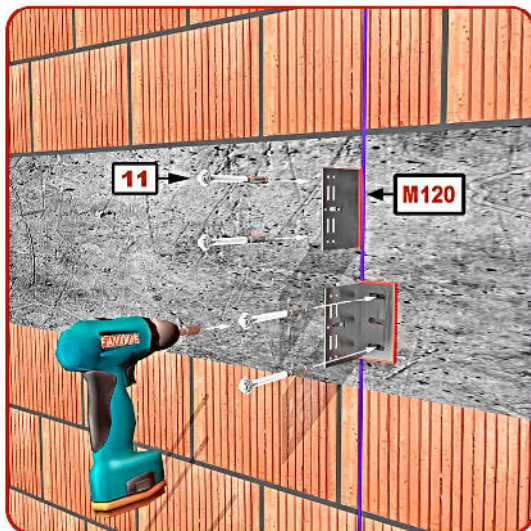
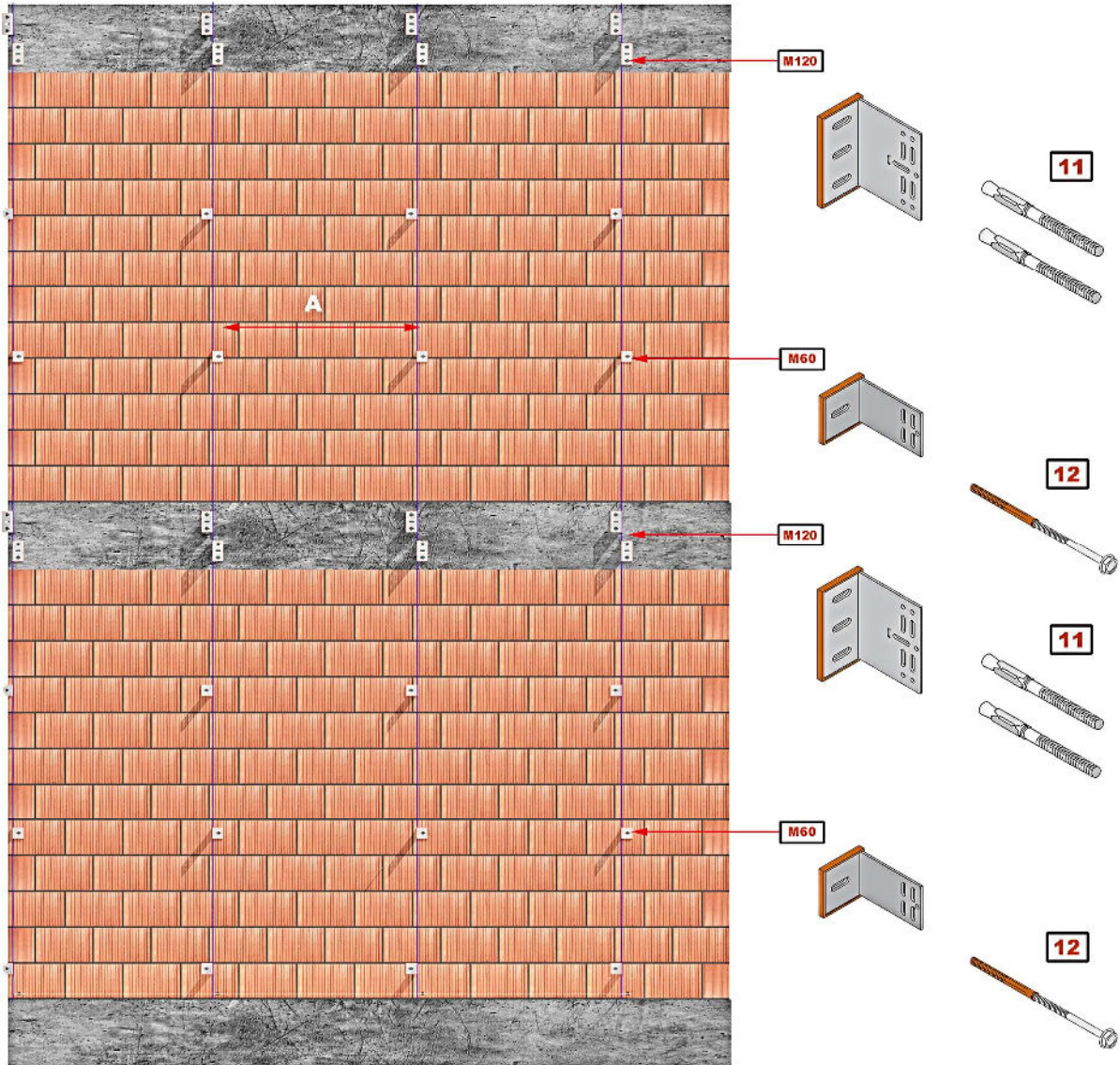

**PASO 6 / STEP 6**

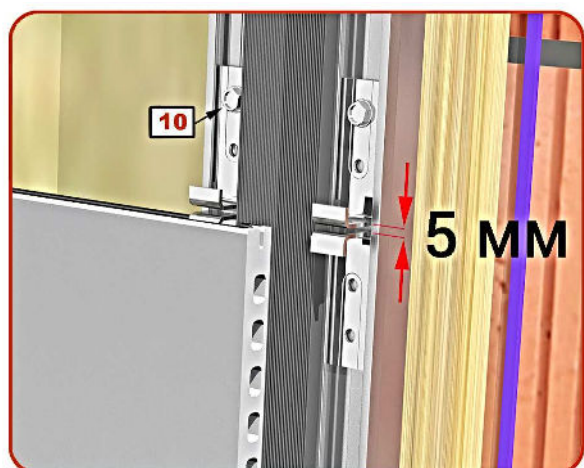
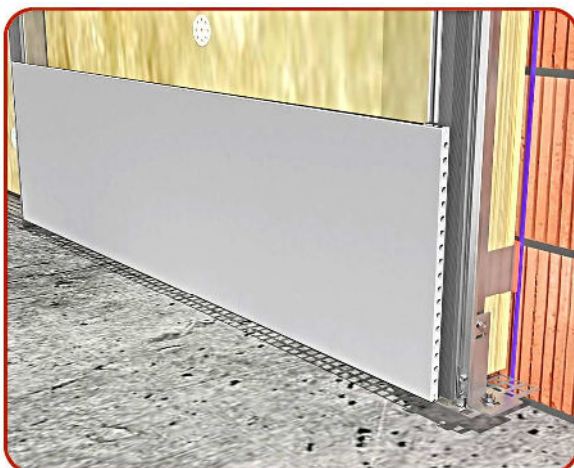
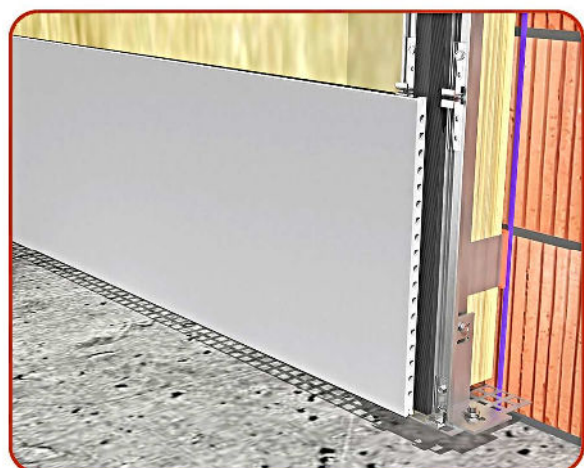
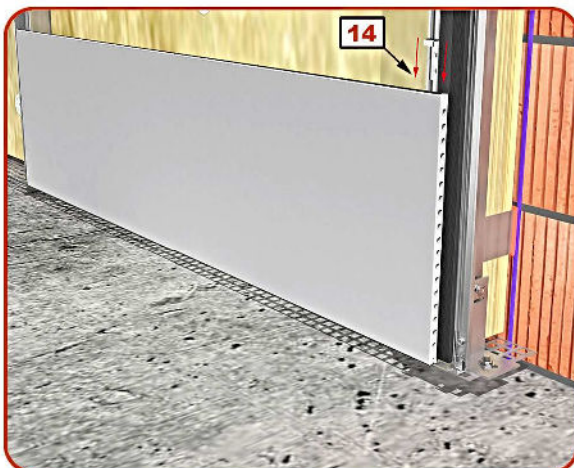
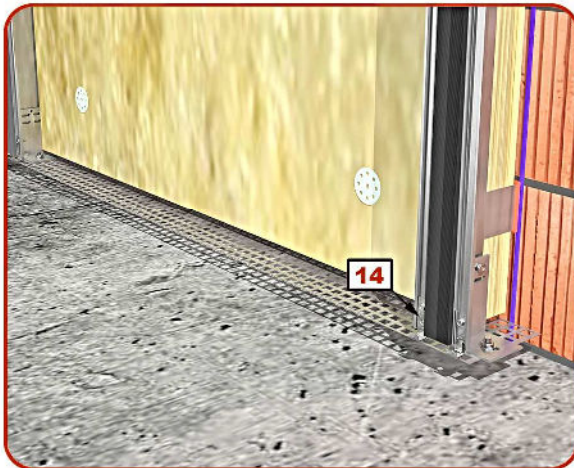

**PASO 6 / STEP 6**

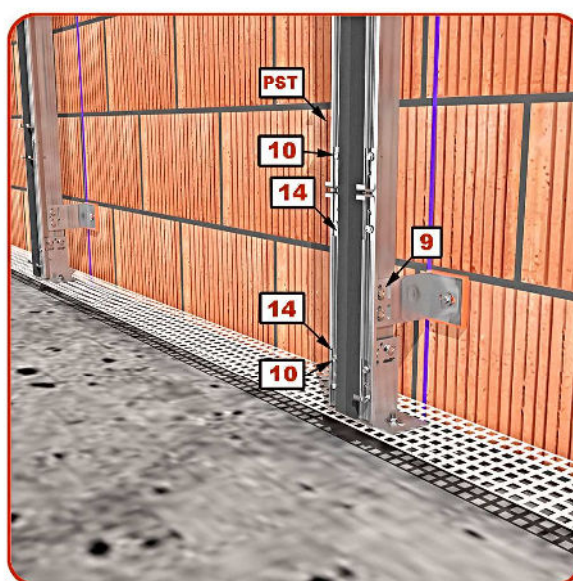
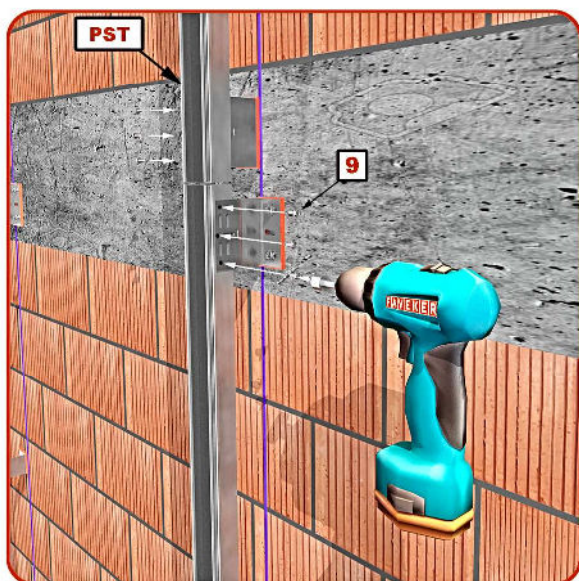
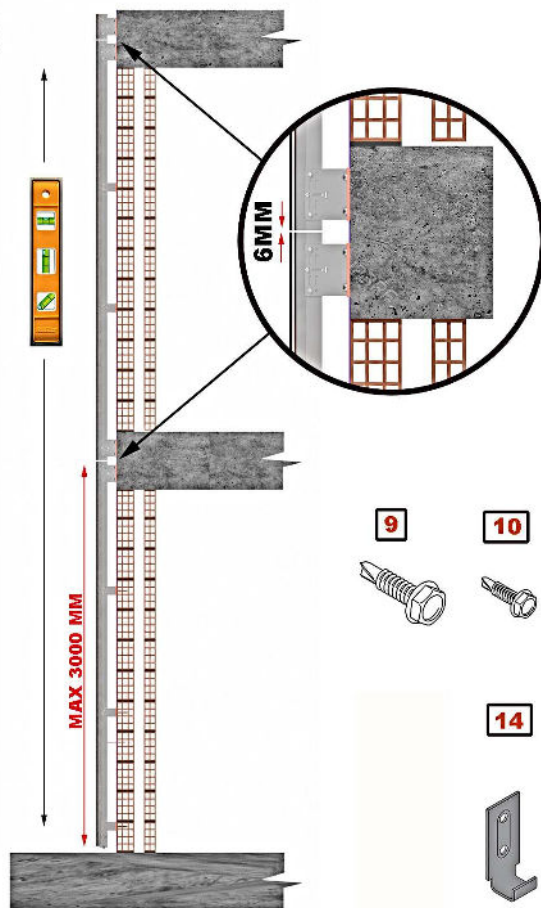
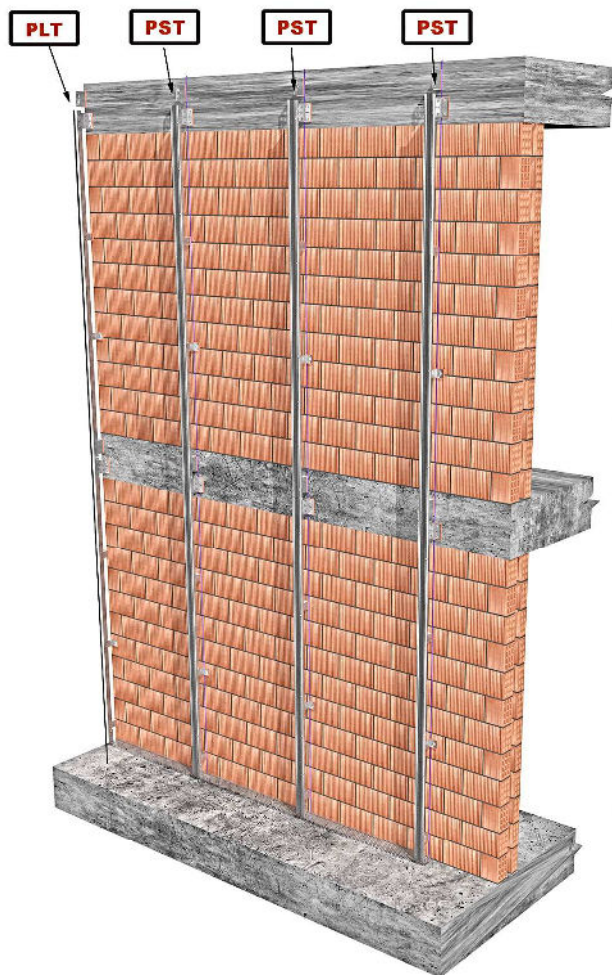



**PASO 7 / STEP 7**

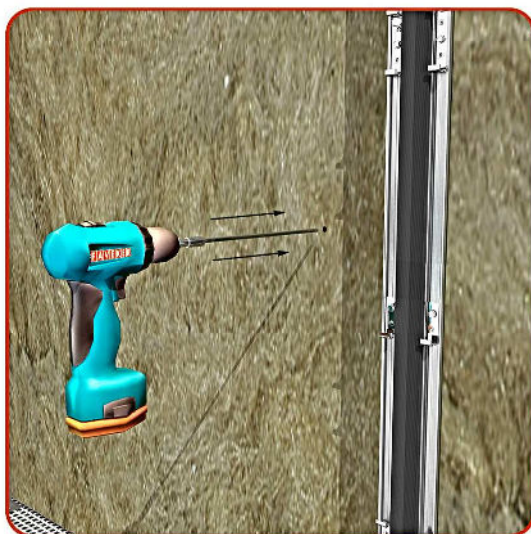
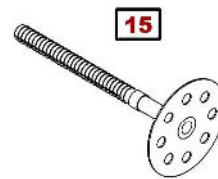
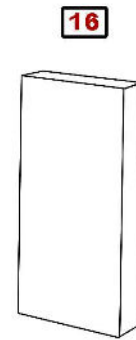
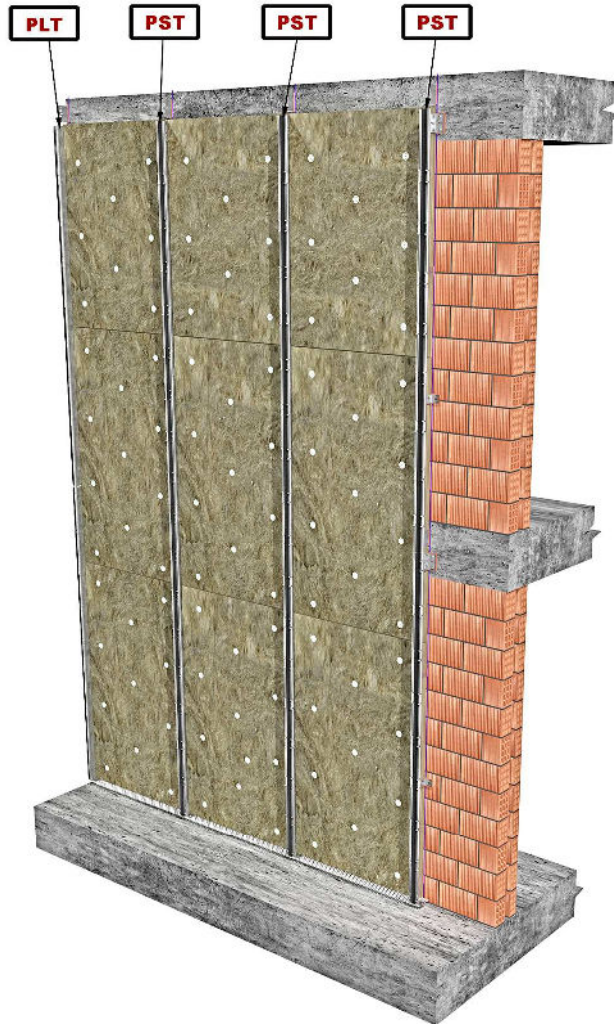

**PASO 8 / STEP 8**

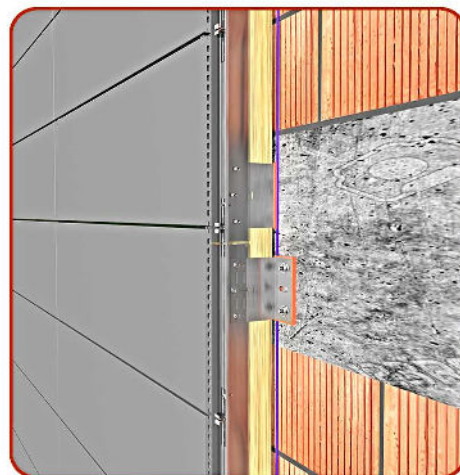
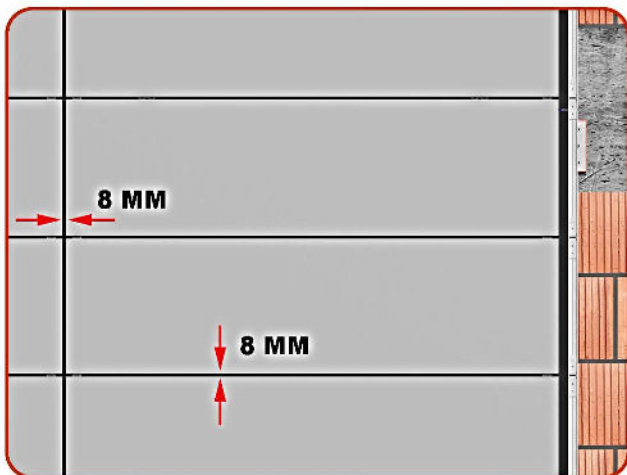
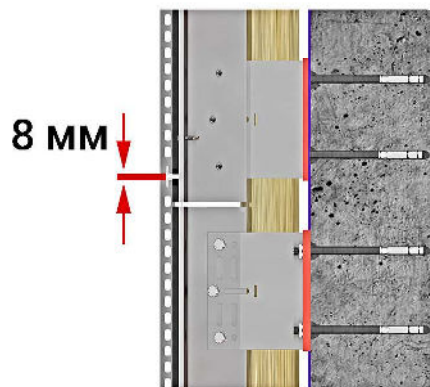
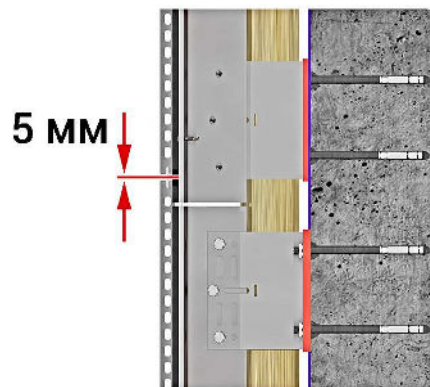
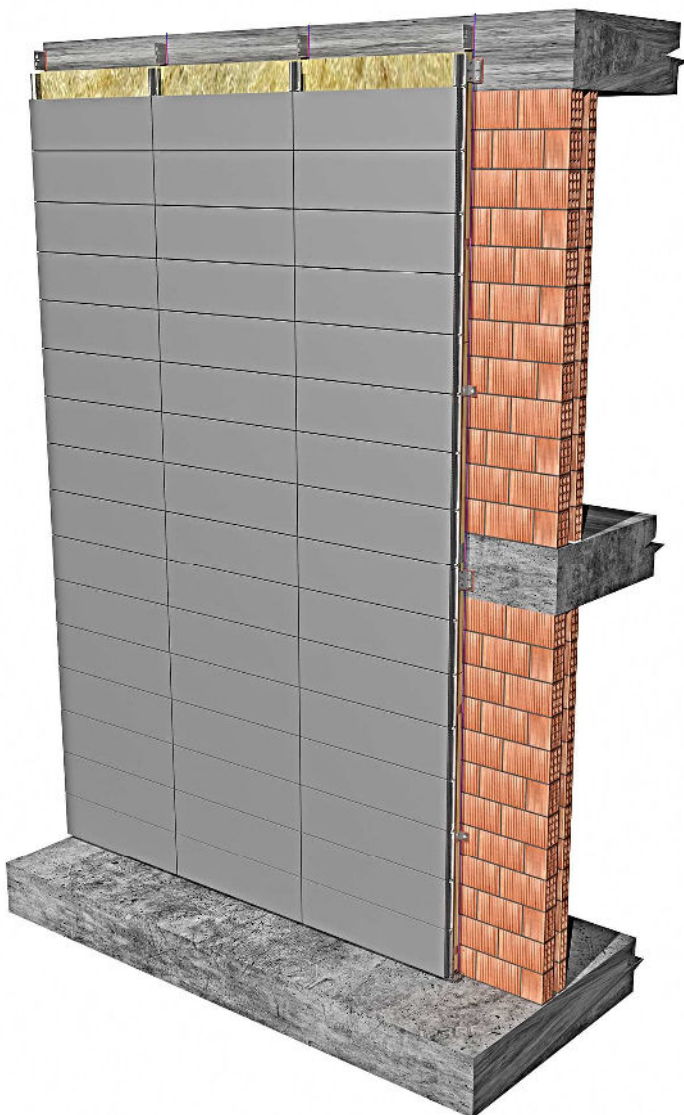

**DETALLE ESQUINAS**  
*CORNERS DETAIL*

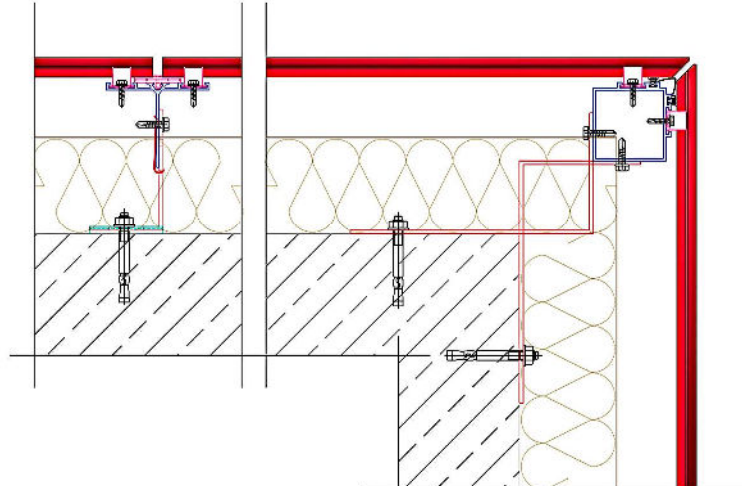

**ESQUINA EXTERIOR**  
*EXTERNAL CORNER*

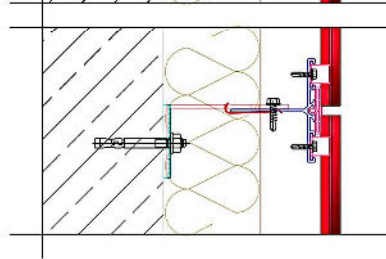

**ESQUINA INTERIOR**  
*INTERNAL CORNER*

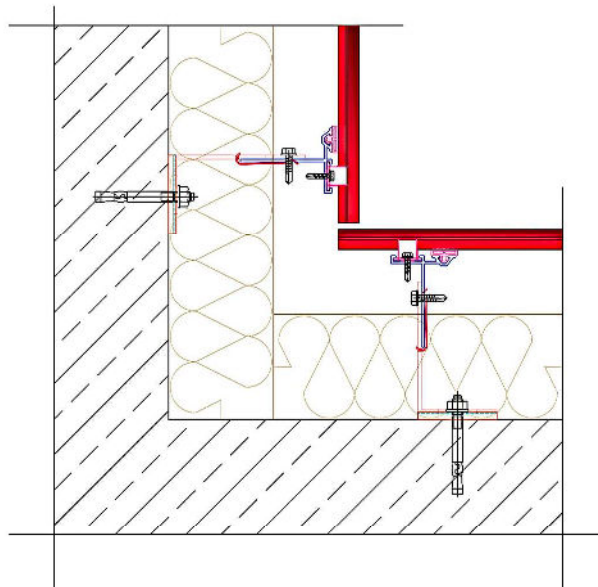

**DETALLES CONSTRUCTIVOS / DETAILS**

Opción lateral cerámica  
CERAMIC LATERAL OPTION

Opción lateral aluminio  
LATERAL ALUMINIUM OPTION

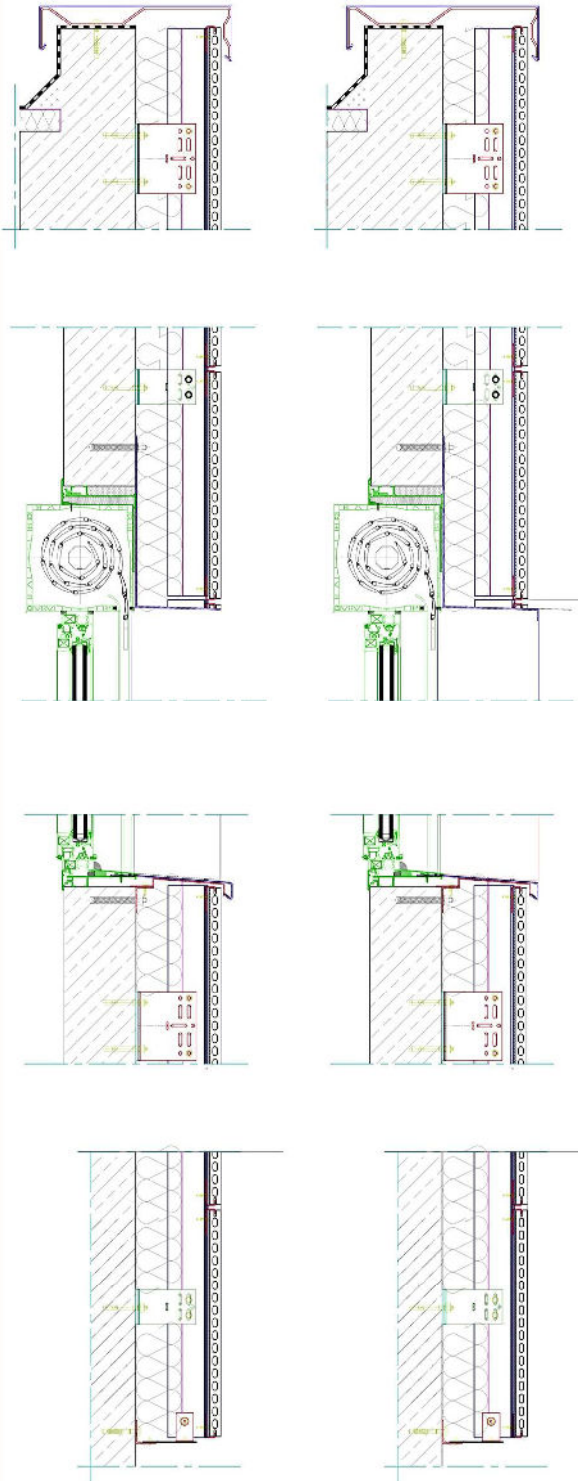

OPCIÓN CON REVEST. CERÁMICO  
CERAMIC OPTION

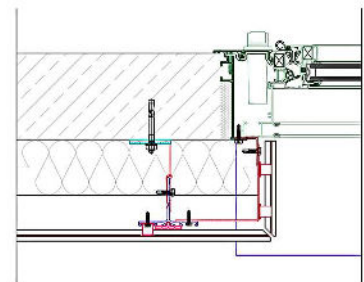

OPCIÓN CON ALUMINIO LACADO  
PAINTED ALUMINIUM OPTION

